

Service manual

GS 64 M 230V 50/60Hz

Version: 2.01

Ident:

Series:

Part-Number: X0600

This part can be ordered.



Chapter

Classic-control Prover 64 M 230V 50/60Hz - V:
door Prover 64 M 230V 50/60Hz - V:
frame Prover 64 M 230V 50/60Hz - V:
tray runners Prover 64 M 230V 50/60Hz - V:
water-energy-unit Prover 64 M 230V 50/60Hz - V:

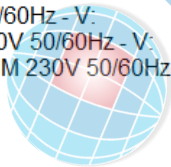

PLATON SERVICE
8 (800) 500-34-4
www.platonservice.com

Service manual Classic-control Prover 64 M 230V 50/60Hz

Version:

Ident:

Series:

Part-Number:



Chapter

- 9030-350-006 - operating unit IS 100 nostalgia
- 9030-350-007 - operating unit IS 100



PLATON SERVICE
8 (800) 500-3444
www.platonservice.com

Part: operating unit IS 100 nostalgia

Part-Number: 9030-350-006

Part: operating unit IS 100

Part-Number: 9030-350-007



PLATON SERVICE

8 (800) 500-34-47

www.platonservice.com

Service manual door Prover 64 M 230V 50/60Hz

Version:

Ident:

Series:

Part-Number:

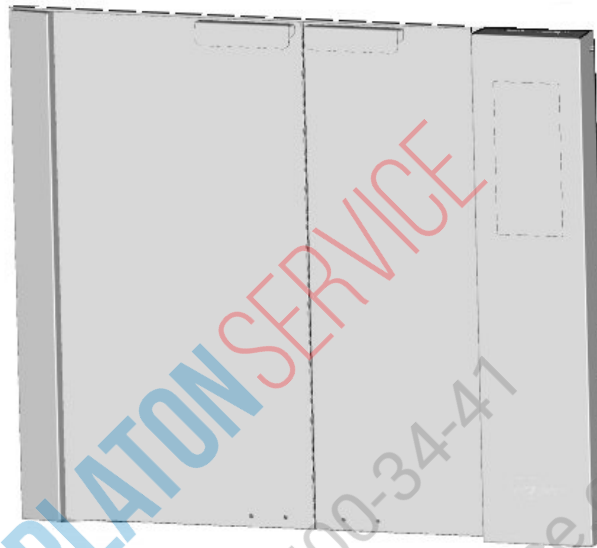

Chapter

door left Prover 64 M 230V 50/60Hz - V:
door right Prover 64 M 230V 50/60Hz - V:

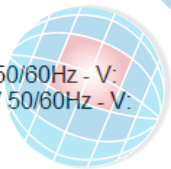

Service manual door left Prover 64 M 230V 50/60Hz

Version:

Ident:

Series:

Part-Number:

Chapter

103611 - collar bushing

9000-198-001 - binder screw brass, 10x5x15mm

9000-198-002 - binder screw nickel-plated, 10x5x15mm

X0600-400-024 - Arbor left

X0600-400-062 - Door left bonded heated VSG

X0600-400-067 - Door bonded left ESG



PLATON SERVICE

8 (800) 500-34-41

www.platonservice.com

Part: collar bushing

Part-Number: 103611

**Part: binder screw brass, 10x5x15mm**

Part-Number: 9000-198-001

**Part: binder screw nickel-plated, 10x5x15mm**

Part-Number: 9000-198-002

**Part: Arbor left**

Part-Number: X0600-400-024

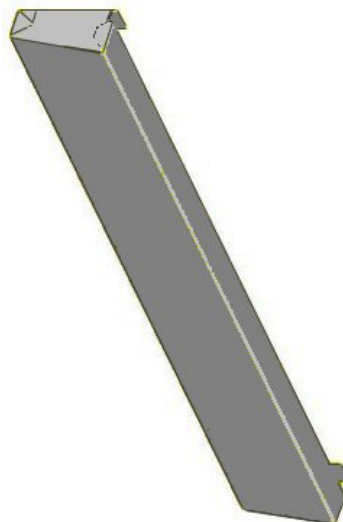

Part: Door left bonded heated VSG

Part-Number: X0600-400-062

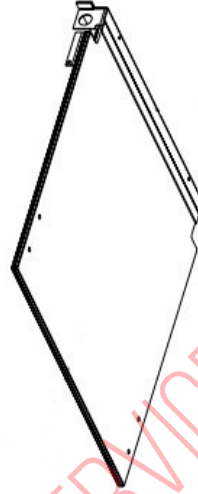

Part: Door bonded left ESG

Part-Number: X0600-400-067

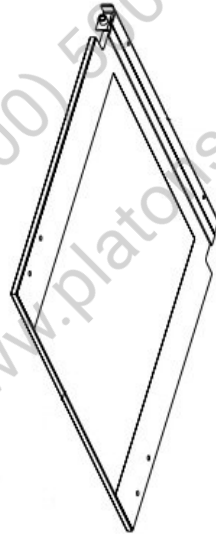

PLATON SERVICE
8 (800) 590-34-47
www.platonservice.com

Service manual door right Prover 64 M 230V 50/60Hz

Version:

Ident:

Series:

Part-Number:

Chapter

103611 - collar bushing

9000-198-001 - binder screw brass, 10x5x15mm

9000-198-002 - binder screw nickel-plated, 10x5x15mm

X0600-400-032 - arbor right

X0600-400-063 - door right bonded heated VSG

X0600-400-068 - door right bonded ESG



PLATON SERVICE

8 (800) 500-34-47

www.platonservice.com

Part: collar bushing

Part-Number: 103611

**Part: binder screw brass, 10x5x15mm**

Part-Number: 9000-198-001

**Part: binder screw nickel-plated, 10x5x15mm**

Part-Number: 9000-198-002



Part: arbor right

Part-Number: X0600-400-032

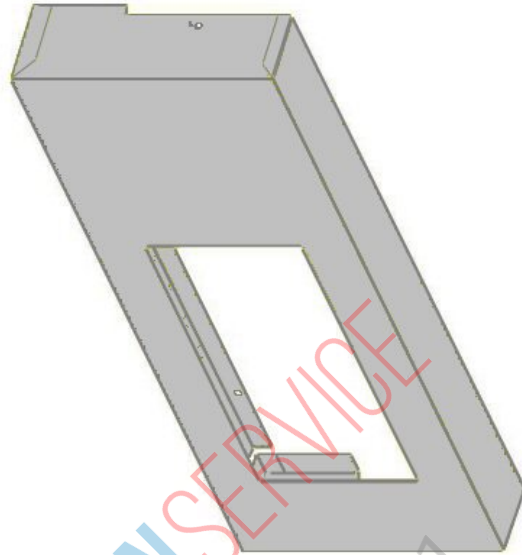

Part: door right bonded heated VSG

Part-Number: X0600-400-063

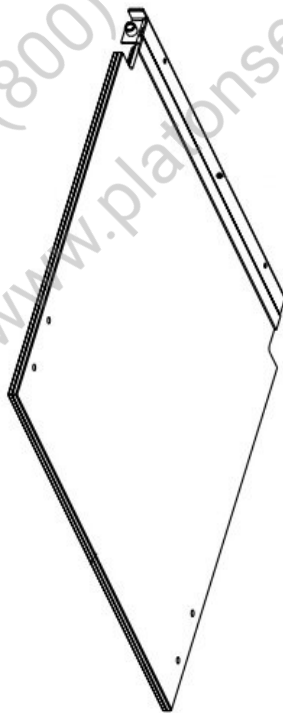

Part: door right bonded ESG

Part-Number: X0600-400-068

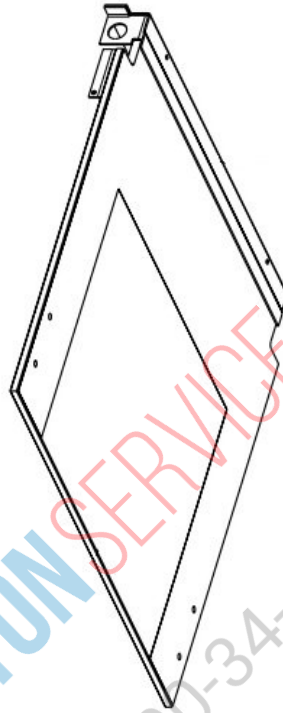

PLATON SERVICE
8 (800) 500-34-47
www.platonservice.com

Service manual frame Prover 64 M 230V 50/60Hz

Version:

Ident:

Series:

Part-Number:

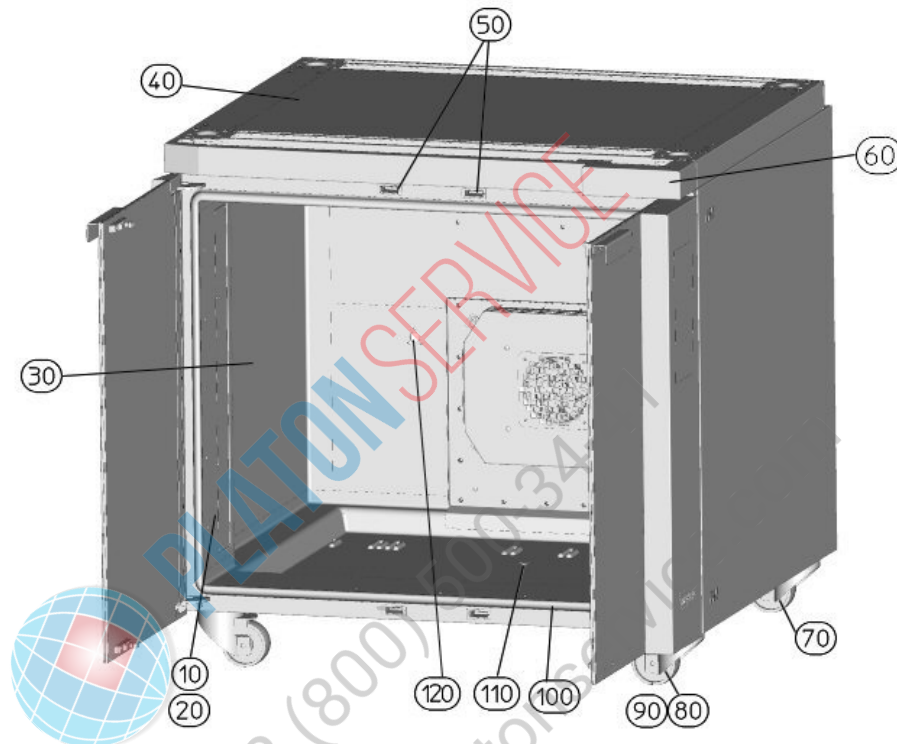

Chapter

- [010] - 102567 - halogen socket
- [020] - 404826 - halogen bulb
- [030] - X0600-500-040 - Side Panel
- [040] - X0700-500-022 - cap
- [050] - 9040-110-002 - spring lock
- [060] - X0600-101-002 - front panel
- [070] - 9050-110-001 - castor with brakes
- [080] - 9050-110-002 - castor
- [090] - 104058 - adjustable foot
- [100] - 38605 - door seal
- [110] - 36149 - plug for water tray
- [120] - 105669 - dual probe

Part: halogen socket**Part-Number: 102567**

Check the porcelain lamp holders and cables for damage. Please do not squeeze or kink the cable.

**Part: halogen bulb****Part-Number: 404826****Part: Side Panel****Part-Number: X0600-500-040****Part: cap****Part-Number: X0700-500-022****Part: spring lock****Part-Number: 9040-110-002****Part: front panel****Part-Number: X0600-101-002**

Part: castor with brakes

Part-Number: 9050-110-001

To allow a simple driving out for maintenance, the wheels should be positioned in the direction of motion so that the wheels do not get stuck.



Part: castor

Part-Number: 9050-110-002

To allow a simple driving out for maintenance, the wheels should be positioned in the direction of motion so that the wheels do not get stuck.



Part: adjustable foot

Part-Number: 104058



Part: door seal

Part-Number: 38605

The door seal is glued with transparent heat resistant silicone (order number 60375) around the radii on the corners and long distances in between. Should the door seal be exchanged then all the silicone must be removed by using a knife. Clean the door tracks and any silicone particles. Make sure when placing the new seal that it is completely in the frame. The seal needs to be pressed around the connecting piece on the top and bottom and in front of the oven with a broach so that it can "breathe". The door seal is a spare part and can be ordered under the number 38605.



Part: plug for water tray

Part-Number: 36149

The plug in the water tub seals the cleaning opening of the proofer. To maintain an optimal climate in the proofer it is necessary to make sure that the plug is always closed when operating the proofer.



Part: dual probe

Part-Number: 105669

The combi sensor measures the moisture and proofer chamber temperature. When installing make sure the slits are always facing down so that moisture will not settle on the measuring points giving off wrong readings.



Service manual tray runners Prover 64 M 230V 50/60Hz

Version:

Ident:

Series:

Part-Number:

Chapter

102552 - tray runners GS1-ED complete (2x5)

103026 - tray runners GS-ED, 5 trays left

103027 - tray runners GS-ED, 5 trays right



PLATON SERVICE

8 (800) 500-34-41

www.platonservice.com

Part: tray runners GS1-ED complete (2x5)**Part-Number: 102552**

Part: tray runners GS-ED, 5 trays left**Part-Number: 103026**

To remove the racks. lift the bottom of the rack upwards. over the plastic securing brackets and pull out sideways. To insert the racks. hook them into the top plastic fasteners first and then affix them to the bottom plastic fasteners.

Part: tray runners GS-ED, 5 trays right**Part-Number: 103027**

To remove the racks. lift the bottom of the rack upwards. over the plastic securing brackets and pull out sideways. To insert the racks. hook them into the top plastic fasteners first and then affix them to the bottom plastic fasteners.



PLATON SERVICE
8 (800) 500-34-41
www.platonservice.com

Service manual water-energy-unit Prover 64 M 230V 50/60Hz

Version:

Ident:

Series:

Part-Number:

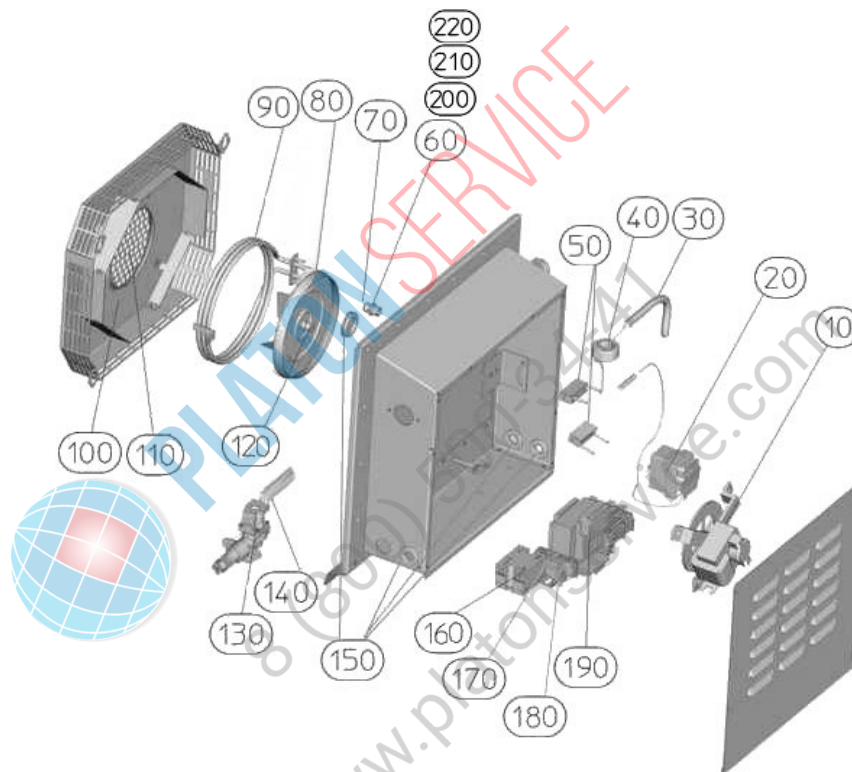

Chapter

- 104476 - hose 3/4"
- X0700-300-001 - water-energy-unit standard
- X0700-300-002 - water-energy-unit Prover-ED heated glass
- 33372 - suppressor element
- [010] - 36106 - motor
- [020] - 102696 - safety limit switch
- [030] - 37804 - cable connection 3,0m/3G 1,5/SchukoZ/230V
- [040] - 36583 - ferrite core R3615X
- [050] - 105726 - condenser
- [060] - 102530 - screwing with spray nozzle
- [070] - 107992 - sealing ring Cu 13x18
- [080] - 105391 - vaporizer
- [090] - 103551 - heating 2000 W
- [100] - 105388 - ventilation cover
- [110] - 105786 - fan grill
- [120] - 103339 - adjusting collar with grub screw
- [130] - 103550 - solenoid valve
- [140] - 33524 - HT - hose silicone D 18xS3 LW12
- [150] - 38525 - nozzle to lead the diaphragm through
- [160] - 34912 - semi-conductor relay 1-pole
- [170] - 34752 - micro-fuse 1A
- [170] - 34753 - micro-fuse 0,5A 5x20
- [180] - 34108 - clamp grey 3L 2.5qmm

- [180] - 34109 - clamp 3L blue 280-684
- [180] - 34110 - clamp 3L 2.5qmm 280-687
- [190] - 100840 - transformer
- [190] - 9030-600-001 - transformer 12V/24V/40V (heated glass)
- [200] - 33350 - brass angle
- [210] - 33355 - Bushing
- [220] - 33358 - hose connection G1/4"



PLATON SERVICE

8 (800) 500-34-47

www.platonservice.com

Part: hose 3/4"**Part-Number: 104476**

Water supply hose 3/4". Inform your customer that the water supply should only be open when the oven is in use. In this manner you can avoid damage.

**Part: water-energy-unit standard****Part-Number: X0700-300-001****Part: water-energy-unit Prover-ED heated glass****Part-Number: X0700-300-002****Part: suppressor element****Part-Number: 33372**

The suppressor element covers the solenoid valve. The prevents EMV disturbances to other compnents in the net.



Part: motor

Part-Number: 36106

For improved baking results the Hanning Motor has two rotating directions and several speeds. In ovens with the IS Control the speed is regulated by the Triac setter. In ovens with a manual control the contactor regulates the speed. The motor is secured with 4 M 6 nuts. The distance sleeves screws that are fixed by locknuts must always have the same height. Tighten the nuts diagonally to avoid tension. The motor has a built in thermo protection (bimetal) that activates at 160° C and automatically resets when cooled down. When the motor protection is activated the motor function is interrupted.



Part: safety limit switch

Part-Number: 102696

After transportation of the appliance please note that the safety temperature limiter (STB) automatically releases with temperatures under +8°C. To allow the appliance to acclimatize let it stand for 30 minutes at room temperature before re-setting the STB. The STB can be re-set as often as needed. Please note that the STB does not activate without reason! Insulate the capillary tube (e.g. on the circuit board) on its critical spots with silicone hose Article number 40074.



Part: cable connection 3,0m/3G 1,5/Schuko/230V

Part-Number: 37804

Part: ferrite core R3615X

Part-Number: 36583

Part: condenserPart-Number: 105726

Part: screwing with spray nozzle

Part-Number: 102530

**Part: sealing ring Cu 13x18**Part-Number: 107992

Part: vaporizer

Part-Number: 105391

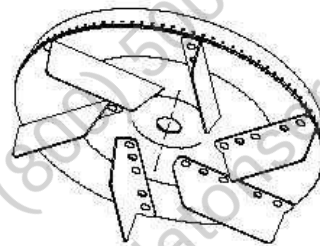
**Part: heating 2000 W**

Part-Number: 103551

We recommend when installing the heater the securing screws are non-threading. Please make sure the heater is correctly situated so that the securing attachments fit through the fan wheel to be connected.



Part: ventilation cover

Part-Number: 105388

Make sure at the end of working with the proofer that the fan cover and safety guard are correctly fastened otherwise there is a risk of injury.

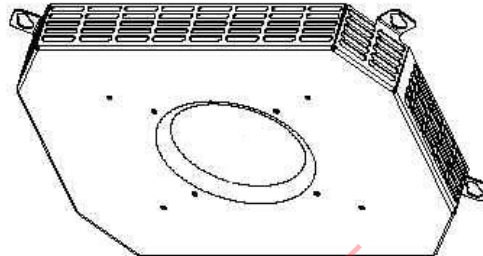

Part: fan grill

Part-Number: 105786

Make sure at the end of working with the proofer that the fan cover and safety guard are correctly fastened otherwise there is a risk of injury.

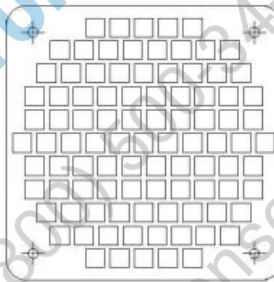

Part: adjusting collar with grub screw

Part-Number: 103339

The middle of the adjusting ring for the rotation sprayer of the motor axel. Please read the installation instructions of the rotation sprayer.



Part: solenoid valve

Part-Number: 103550

It is necessary to clean the dirt sieve of the solenoid valve regularly. Particles in the water line will stick to the sieve and interrupt the water flow. Please note the maximum water pressure and other warnings from the data sheets regarding the water connection. The solenoid valve is a valve for the steaming filler as well as for the automatic cleaning process Pro Clean. The solenoid valve works with a flow pressure of 150 - 600 kPa. You can test the solenoid valve function in the PC - Tool - Test. Attention the test is a continued test and this function is not protected from overload.



Part: HT - hose silicone D 18xS3 LW12

Part-Number: 33524



Part: nozzle to lead the diaphragm through

Part-Number: 38525

To reset the safety temperature limit switch the fan cover which is found in the interior of the proofer must be removed. The knob is protected from spray and steam under a membrane case. By firmly pressing the covered key the safety temperature limit can be re-set. Please note that the STB does not activate without reason!



Part: semi-conductor relay 1-pole

Part-Number: 34912

The solid state relay controls the heater. Depending on the temperature this will automatically switch it on or off. (type can vary)



Part: micro-fuse 1A

Part-Number: 34752



Part: micro-fuse 0,5A 5x20

Part-Number: 34753



Part: clamp grey 3L 2.5qmm

Part-Number: 34108

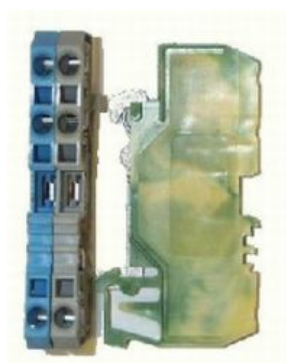

Part: clamp 3L blue 280-684**Part-Number: 34109****Part: clamp 3L 2.5qmm 280-687****Part-Number: 34110****Part: transformer****Part-Number: 100840**

The lighting transformer provides power to the baking chamber. The interior lighting is (2x12V/20W) Please note the wiring when removing/inserting. The wire should not come in contact with the circuit board. This may cause sporadic interference with the electronics.

**Part: transformer 12V/24V/40V (heated glass)****Part-Number: 9030-600-001**

Part: brass angle

Part-Number: 33350

**Part: Bushing**

Part-Number: 33355

**Part: hose connection G1/4"**

Part-Number: 33358



PLATON SERVICE
8 (800) 500-34-47
www.platonservice.com

Urheberrecht:

Das Urheberrecht an diesem Servicehandbuch verbleibt bei der WIESHEU GmbH. Dieses Servicehandbuch ist nur für autorisierte Servicepartner und dessen Personal bestimmt. Sie enthält Vorschriften und Hinweise, die weder vollständig noch teilweise vervielfältigt, verbreitet oder anderweitig mitgeteilt werden dürfen.

Alle Darstellungen, Zeichnungen, Bilder Texte und Angaben sind urheberrechtlich geschützt. Sie unterliegen den gewerblichen Schutzrechten.

Zu diesem Servicehandbuch:

Alle Abbildungen in diesem Dokument sollen die Verständlichkeit unterstützen. Die Abbildungen sind nicht maßstabsgerecht. Teilweise sind dem Originalprodukt ähnelnde Abbildungen dargestellt, die geringfügig abweichen können.

Achtung!

Vermeiden Sie Fehlfunktionen oder Beschädigungen durch falsche Ersatzteile. Wir empfehlen die ausschließliche Verwendung von WIESHEU-Original-Ersatzteilen.

Wiesheu GmbH
Daimlerstrasse 10
DE-71563 Affalterbach
Telefon: +49 (0)7144 / 3 03-0
Fax: +49 (0)7144 / 3 03-11
Service-Telefon: 0800-WIESHEU
E-Mail: info@wiesheu.de
www.wiesheu.de

Stand: 9/10/2012



PLATON SERVICE

8 (800) 500-34-41

www.platonservice.com